



BETA RICAMBI

Tel. 081 8507823 / 8638945 - Fax 081 8500351

PROFILI IN ALLUMINIO E FERRO

Beta Ricambi

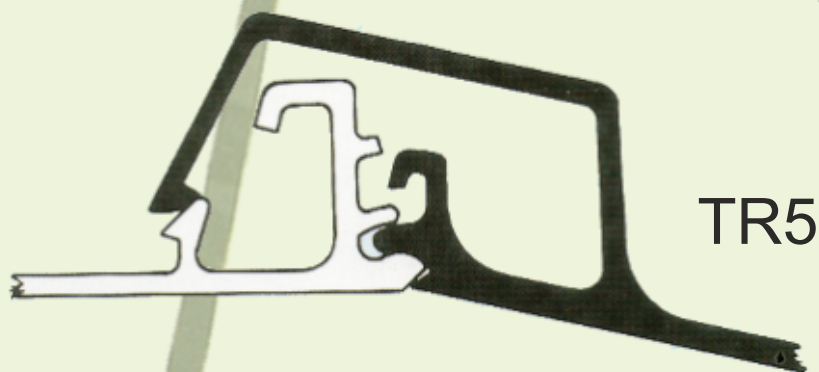
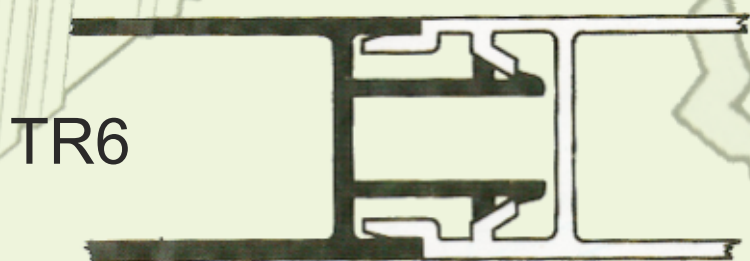

SPONDE IN FERRO



TR1

Beta Ricambi

PROFILI SUPERIORI



H	L
200	6000
200	6800
200	7500

Cod. 1541183

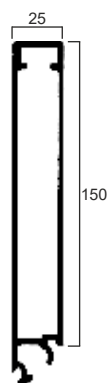

H	L
150	6000
150	7500

Cod. 1541308

Beta Ricambi

PROFILI INFERIORI

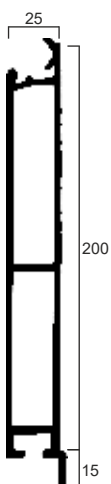

H	L
200	6000
200	6800
200	7500

Cod. 1541185

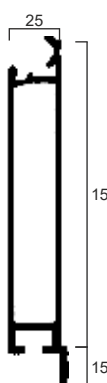

H	L
150	6000
150	7500

Cod. 1541310

Beta Ricambi

PROFILI INFERIORI



NG041

H	L
200	6000
200	6800
200	7500

Cod. 1541314



H	L
200	7500

BATTUTA INVERSA

Cod. 1541311



TR1

Beta Ricambi

PROFILI INTERMEDI APERTI

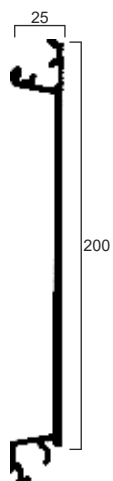

H	L
200	6000
200	6800
200	7500

Cod. 1541184

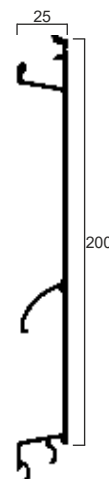

H	L
200	6000
200	6800
200	7500

Cod. 1541767

Beta Ricambi

PROFILI INTERMEDI APERTI

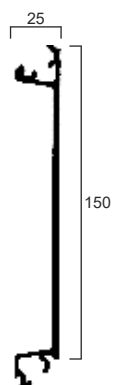

H	L
150	6000
150	7500

Cod. 1541306

Beta Ricambi

PROFILI INTERMEDI CHIUSI

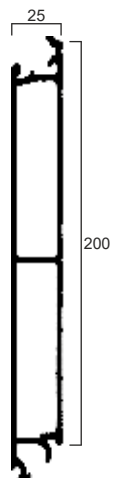

H	L
200	6000
200	6800
200	7500

Cod. 1541186

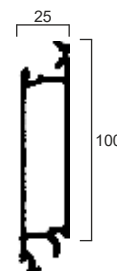

H	L
100	6000
100	7500

Cod. 1541307



TR1

Beta Ricambi

PROFILI PER SPONDE RIBALTABILI

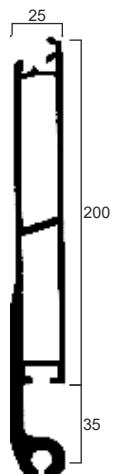

H	L
200	6000
200	6800
200	7500

Cod. R 7349

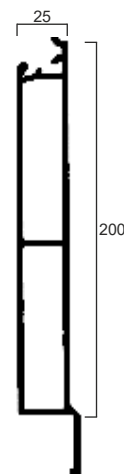

H	L
200	6000
200	7500

Cod. 1541410

Beta Ricambi

PROFILI PER SPONDE RIBALTABILI

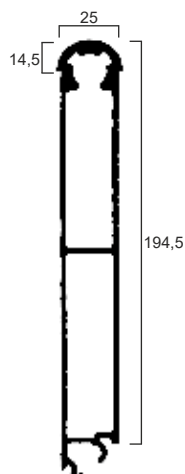

H	L
200	6000
200	7500

Cod. 1541408

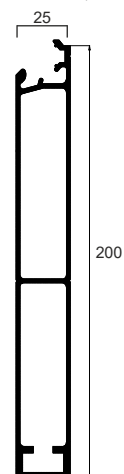

H	L
200	7500

Cod. 1541358

Beta Ricambi



TR6

Beta Ricambi

PROFILI SUPERIORI

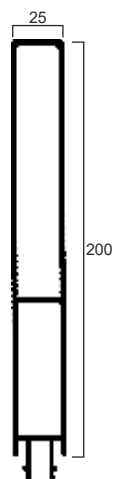

H	L
200	6000
200	6600
200	7500

Cod. 1541379

Beta Ricambi

PROFILI INTERMEDI

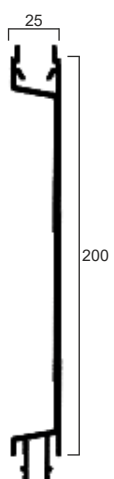

H	L
200	6000
200	6600
200	7500

Cod. 1541365



H	L
200	6000
200	6600
200	7500

Cod. 1541362

Beta Ricambi

PROFILI INFERIORI

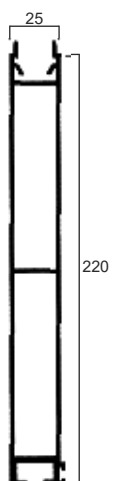

NG041

H	L
220	6000
220	6600
220	7500

Cod. 1541381



H	L
200	6000
200	6600
200	7500

Cod. 1541364



TR5

Beta Ricambi

PROFILI SUPERIORI

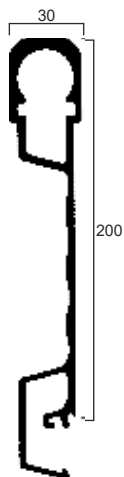

H	L
200	6000
200	6500
200	7500

Cod. 1541392

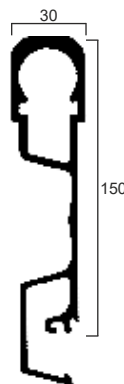

H	L
150	6000
150	7500

Cod. 1541393

Beta Ricambi

PROFILI INTERMEDI

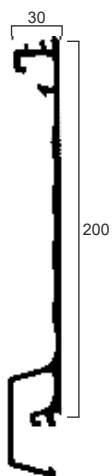

H	L
200	6000
200	6500
200	7500

Cod. 1541391

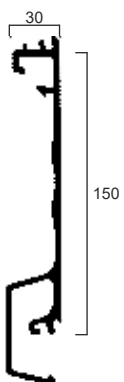

H	L
150	6000
150	7500

Cod. Al 0204

Beta Ricambi

PROFILI INFERIORI

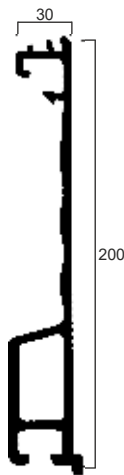

H	L
200	6000
200	6500
200	7500

Cod. 1541356

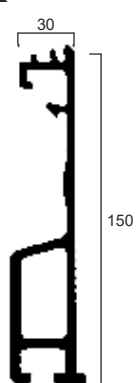

H	L
150	6000
150	7500

Cod. 1541361



BETA RICAMBI

Tel. 081 8507823 / 8638945 - Fax 081 8500351

TR5

Beta Ricambi

PROFILI INFERIORI

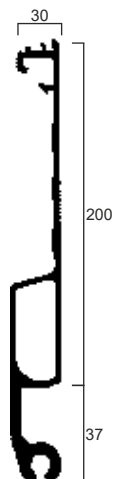

H	L
200	6000
200	6500
200	7500

Cod. 1541559

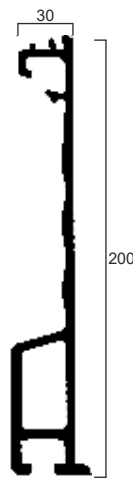

H	L
200	7500

Cod. 1541385

Beta Ricambi

Beta Ricambi



DUMPER 1°SERIE

Beta Ricambi

PROFILI SUPERIORI

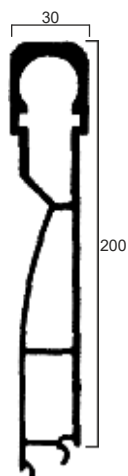

H	L
200	6200
200	7500

Cod. 25457

Beta Ricambi

PROFILI INTERMEDI

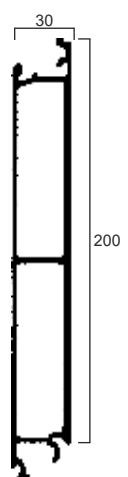

H	L
200	6200
200	7500

Cod. 25455

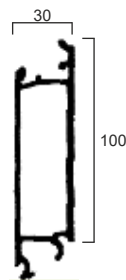

Cod. 25456

H	L
100	6200
100	7500

Beta Ricambi

PROFILI INFERIORI

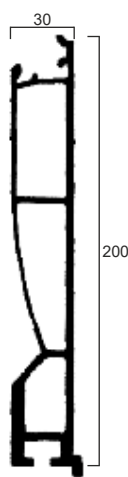

H	L
200	6200
200	7500

Cod. 25458

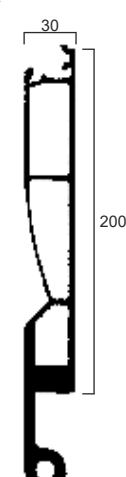

Cod. 25454

H	L
200	6200
200	7500



DUMPER 2°SERIE

Beta Ricambi

PROFILI SUPERIORI

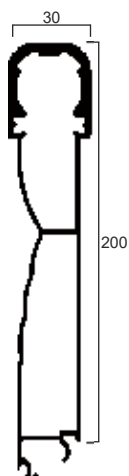

H	L
200	6200
200	7500

Cod. 1545096

Beta Ricambi

PROFILI INTERMEDI

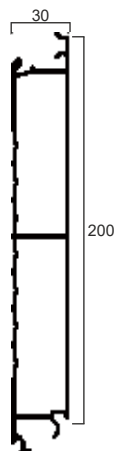

H	L
200	6200
200	7500

Cod. 1545099

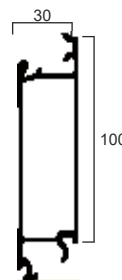

Cod. 1545100

H	L
100	6200
100	7500

Beta Ricambi

PROFILI INFERIORI



H	L
200	6200
200	7500

Cod. 1545097

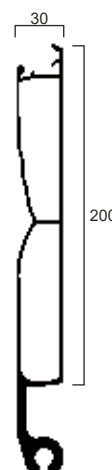

Cod. 1545098



SPONDE MONOPROFILO

Beta Ricambi

SPONDE DA 25mm

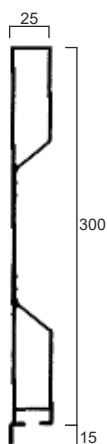

Cod. R 7031

H	L
300	5800

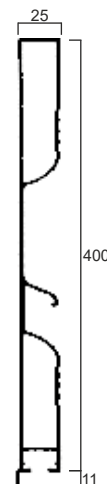

Cod. R 6018

H	L
400	6000
400	6500
400	7500

Beta Ricambi

SPONDE DA 25mm RINFORZATE

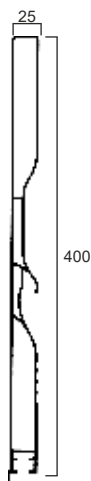

Cod. R12415

H	L
400	6500
400	7500

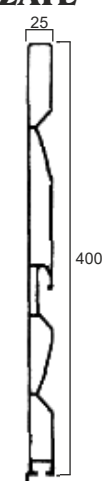

Cod. S0227482

H	L
400	6500
400	7500

Beta Ricambi

SPONDE DA 30mm DUMPER

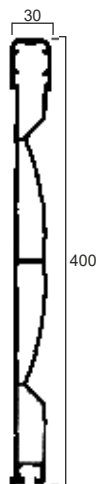

Cod. 27483

1° SERIE

H	L
400	6500
400	7500

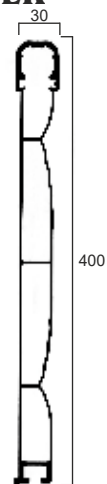

Cod. 1545067

2° SERIE

H	L
400	6500
400	7500



PROFILI COMPLEMENTARI

Beta Ricambi

SOVRASPONDE DA 25mm

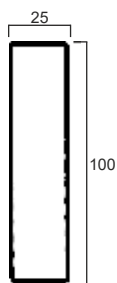

Cod. 1541318

H	L
100	6000
100	6800
100	7500

Beta Ricambi

SOVRASPONDA DA 25mm RINFORZATA

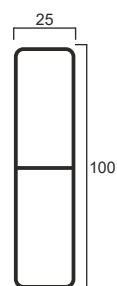

Cod. AR1083

H	L
100	6000
100	6800
100	7500

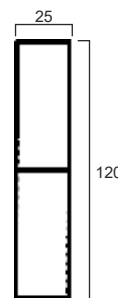

Cod. 1541114

H	L
120	6000
120	6800
120	7500

Beta Ricambi

SOVRASPONDE FRANCESI GREZZE

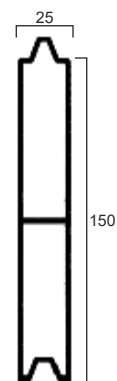

Cod. 1541615

H	L
150	6000
150	6500
150	7500

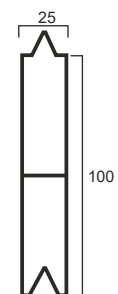

Cod. 1541761

H	L
100	6500



PROFILI COMPLEMENTARI

Beta Ricambi

PROFILI PARACICLI

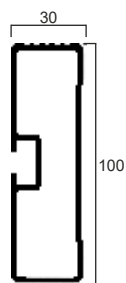

Cod. R7282

H	L
100	6000
100	7500

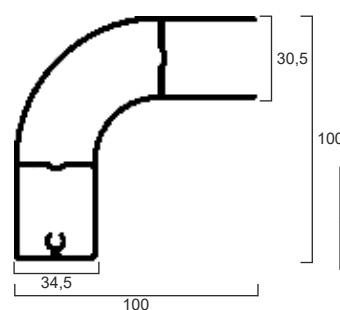

Cod. R7297

L
6000

Beta Ricambi

ANGOLARI ALLUMINIO

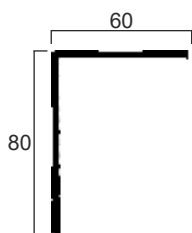

Cod. Al0026

H	L
800	7500

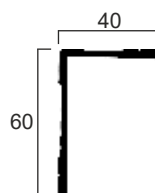

Cod. Al0023

H	L
600	7500

Beta Ricambi

ANGOLARI ALLUMINIO ANTERIORI

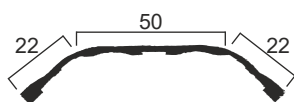

Cod. S0222370-60

L
6000

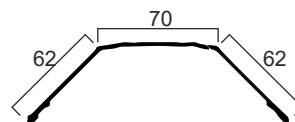

Cod. S0224285-60

L
6000



PROFILI COMPLEMENTARI

Beta Ricambi

ANGOLARI ALLUMINIO

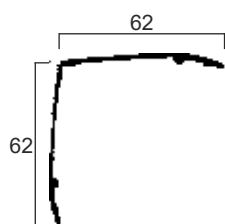

L
7500

Cod. Al649-75

Beta Ricambi

ANGOLARE ALLUMINIO PER ADESIVI CATARIFRANGENTI

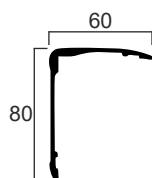

L
7500

Cod. NA067

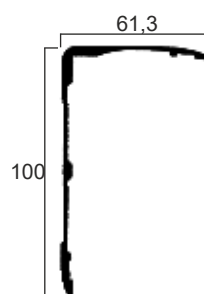

L
7500

Cod. NA057

Beta Ricambi

PROFILI BATTISCOPIA



H	L
285	7500

Cod. 1542461-75

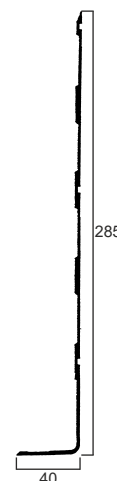

H	L
285	7500

Cod. 1542462-75



PROFILI COMPLEMENTARI

Beta Ricambi

TERMINALI VIBERTI



POSTERIORE

L
1015

Cod. NA036



LATERALE

L
1015

Cod. NA032

Beta Ricambi

TERMINALI NORMALI

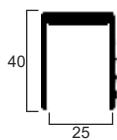

Cod. 1541305

H	L
40	6000

Beta Ricambi

TERMINALI CON BATTUTA

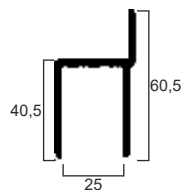

Cod. 1541312

H	L
40,5	6000

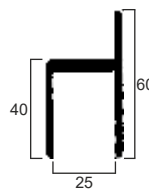

Cod. 1541313

H	L
40	6000



PROFILI COMPLEMENTARI

Beta Ricambi

TERMINALI

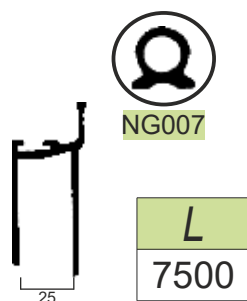

Cod. 1542274

ALLUMINIO TERMINALE PASINO

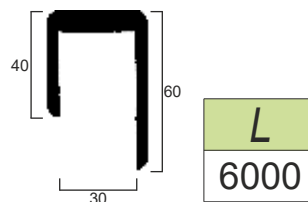

Cod. 1541357

ALLUMINIO TERMINALE TR5

Beta Ricambi

TERMINALI

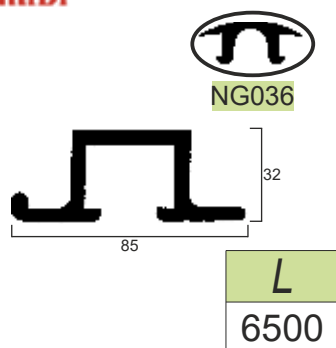

Cod. S0221092-65

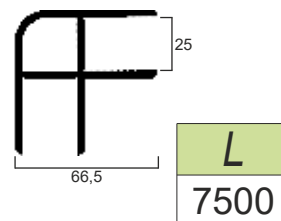

Cod. NA062

Beta Ricambi

TERMINALI

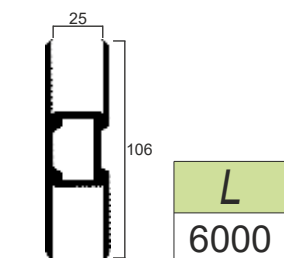

Cod. S0250035-60

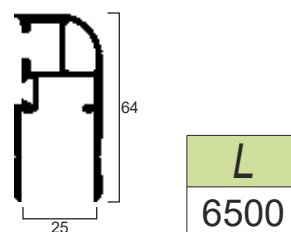

Cod. S0214298-65



PROFILI COMPLEMENTARI

Beta Ricambi

TERMINALI REGISTRABILI



NG041

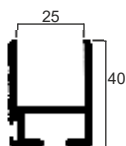

H	L
40	6000

Cod. 1541396



NG041

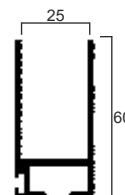

L	H
6000	60

Cod. NT198

Beta Ricambi

PROFILI TENSITELO GREZZO

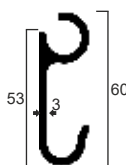

L
6000
6500
7500

Cod. AB0001

PROFILI TENSITELO ANODIZZATO

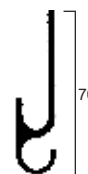

L
6500

Cod. S0213870-65

Beta Ricambi

PROFILI PIANALE GREZZO APERTI

H	L
30	7500

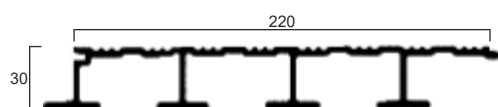

Cod. 1543080

H	L
40	7500

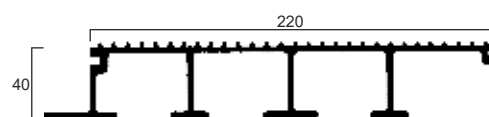

Cod. 1543023



PROFILI COMPLEMENTARI

Beta Ricambi

PROFILI PIANALE GREZZO CHIUSI

H	L
30	7500

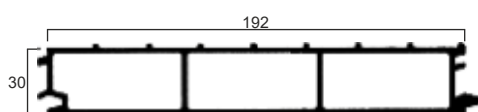

Cod. 1543034

H	L
40	7500

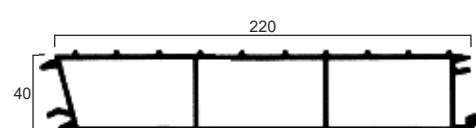

Cod. 1543030

Beta Ricambi

PROFILI IN GOMMA PER ALLUMINIO



Cod. NG041

PER
PROFILO INFERIORE
TR1, TR6

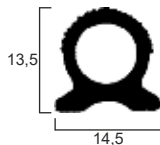

Cod. NG007

PER
TERMINALE PASINO



Cod. NG036

PER
PROFILO OMEGA



Cod. NG010

PER PROFILO INFERIORE
VIBERTI

Beta Ricambi



SOVRASPONDE

Beta Ricambi

MENSOLE SOVRASPONDE

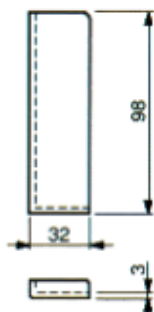

CODICE	DESCRIZIONE
NM096	Piastr. mens. reg. DX
NM096S	Piastr. mens. reg. SX

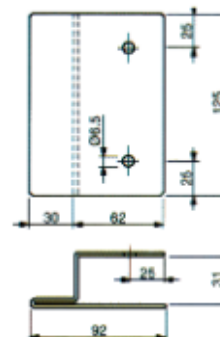

CODICE	DESCRIZIONE
NM035	Mensola sovr. regol.

Beta Ricambi

MENSOLE SOVRASPONDE

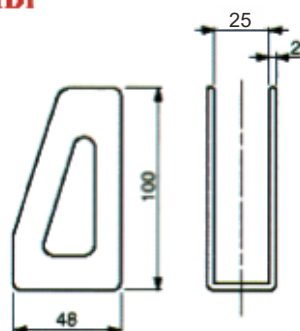

CODICE	DESCRIZIONE
NM053	Mensola sovrasp. ferro
NM007	Mensola sovrasp. inox

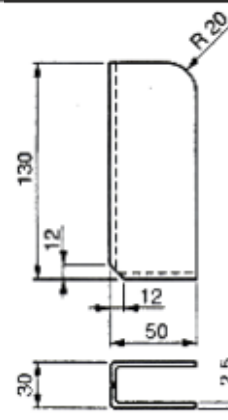

CODICE	DESCRIZIONE
NM053A	Per sovrasponda H15

Beta Ricambi

TAPPI PARACICLI IN PLASTICA



CODICE	DESCRIZIONE
NT120	Tappo dritto H100



CODICE	DESCRIZIONE
NT115	Tappo curvo H100



TAPPI SOVRASPONDE

Beta Ricambi

TAPPI PER SOVRASPONDE IN GOMMA

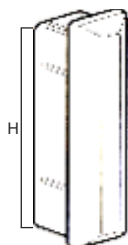

H

100

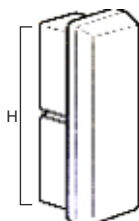

H

100

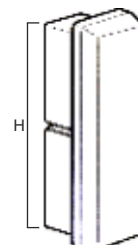

H

120

CODICE	DESCRIZIONE
NT049	Tappo gomma

CODICE	DESCRIZIONE
NT158	Tappo gomma c/spacco

CODICE	DESCRIZIONE
45159	Tappo gomma c/spacco

Beta Ricambi

TAPPI PER SOVRASPONDE IN PLASTICA

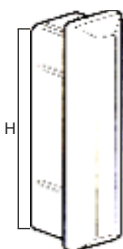

H

100

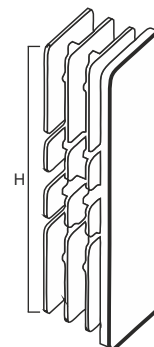

H

100

CODICE	DESCRIZIONE
45153	Tappo plast. alto

CODICE	DESCRIZIONE
45154	Tappo plast. c/spacco

Beta Ricambi

TAPPI PER SOVRASPONDE FRANCESI

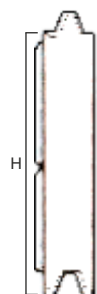

H

100

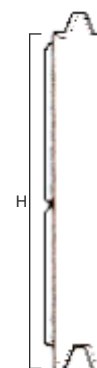

H

150

CODICE	DESCRIZIONE
NT165	Tappo plastica

CODICE	DESCRIZIONE
NT118	Tappo plastica



PROFILI IN FERRO

Beta Ricambi

SPONDE



CODICE	H	L	±
NS169	300	6000	15/10
NS141	350	6000	15/10
NS037	400	6000	15/10
NS052	450	6000	15/10
NS029	500	6000	15/10
NS184	600	6000	20/10
NS044	700	6000	25/10
NS233	800	6000	25/10

Beta Ricambi

CENTRALI

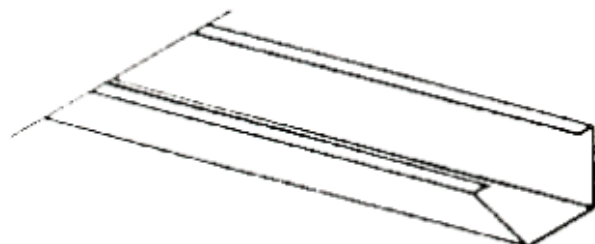

CODICE	H	L	±
NT077	300	217	15/10
NT107	350	278	15/10
NT101	400	318	15/10
NT019	450	370	15/10
NT098	500	420	15/10
NT104	600	515	20/10
NT020	700	619	25/10
NT051	800	695	25/10

Beta Ricambi

TERMINALI

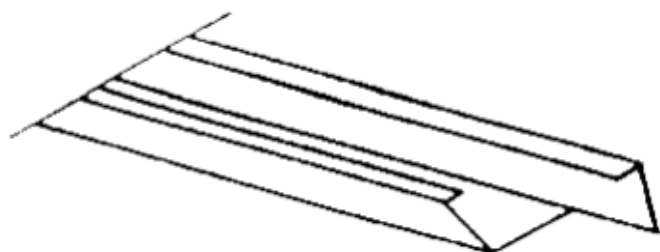

CODICE	H	L	±
NT103	300	300	15/10
NT106	350	350	15/10
NT102	400	400	15/10
NT092	450	450	15/10
NT097	500	500	15/10
NT105	600	600	20/10
NT001	700	700	25/10
NT061	800	800	25/10



PROFILI IN FERRO

Beta Ricambi

LONGHERINE IN FERRO

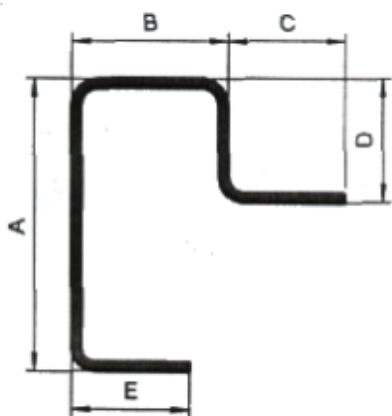

CODICE	L	$\frac{t}{mm}$	A	B	C	D	E
NF115	6000	3	84	40	27	18	22
NF116	6150	3	141	50	40	35	40

Beta Ricambi

LONGHERINE IN FERRO TIPO VIBERTI

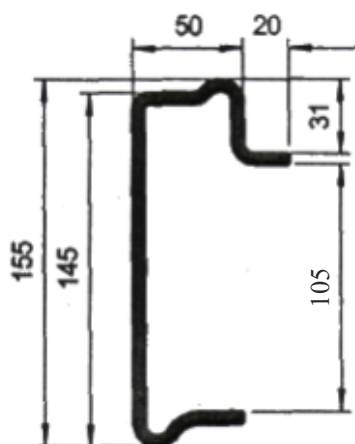

CODICE	L	$\frac{t}{mm}$
NF089	6500	3,5
NF089L	8300	3,5

Beta Ricambi



MULTISTRATO PER PIANALI

Beta Ricambi

MULTISTRATO

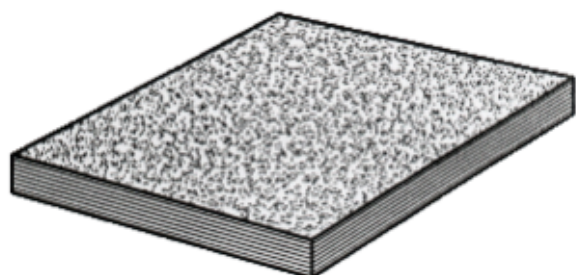





CODICE	$\frac{t}{mm}$	Larg.	Lung.
NA092	9	1250	2500
NA047	12	1250	2500
NA041	15	1250	2500
NA006	18	1250	2500
NA052	21	1250	2500
NA011	24	1250	2500
NA018	27	1250	2500
NA007	30	1250	2500
NA014	35	1250	2500

CODICE	$\frac{t}{mm}$	Larg.	Lung.
NA053	15	1525	2500
NA049	18	1525	2500
NA118	21	1525	2500
NA117	24	1525	2500
NA119	27	1525	2500
NA073	30	1525	2500
NA066	35	1525	2500

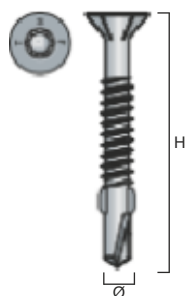
Beta Ricambi

PERNI MULTISTRATO TORX



-  Pre-foro non necessario
-  Impronta a 6 lobi
-  Autoperforante

CODICE	Ø	H
NP571	6,3	40
NP622	6,3	55
NP044	6,3	70



LAMIERE E TUBOLARI

Beta Ricambi

ALLUMINIO MANDORLATO

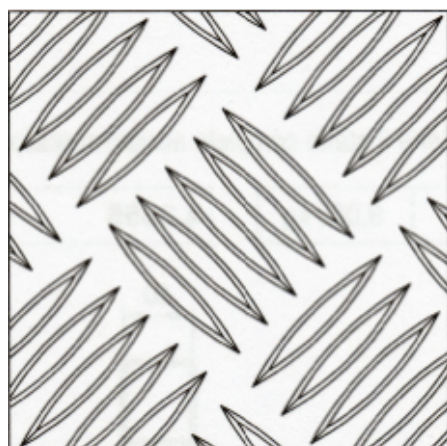

CODICE	H	L	±
14.000	1000	2000	20/10
22.000	1250	2500	20/10
30.000	1250	2500	30/10
29.000	1500	3000	20/10
76.800	2000	4000	30/10

Beta Ricambi

LAMIERE INOX FIORETTATE



CODICE	H	L	±
NI001	1250	2500	8/10
NI002	1250	2500	10/10

Ampia disponibilità di
misure e spessore

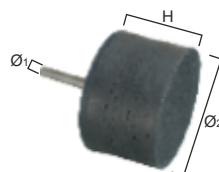

CODICE	Ø ₁	Ø ₂	H
NT073	6	60	30

Tampone per rosettare

Beta Ricambi

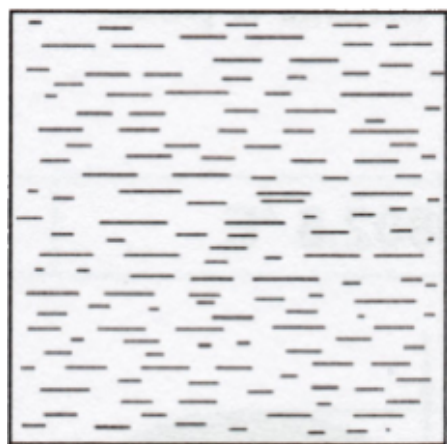

Ampia disponibilità di:

- LAMIERE IN FERRO
- LAMIERE IN ACCIAIO
- LAMIERE IN ALLUMINIO



BETA RICAMBI

Tel. 081 8507823 / 8638945 - Fax 081 8500351

Beta Ricambi